

**RANGER 8600**  
**DOWNLOADABLE CONTROL COMMUNICATOR**  
**INSTALLATION MANUAL**

**TABLE OF CONTENTS**

GENERAL DESCRIPTION .....	2
STANDARD AND OPTIONAL PARTS LIST .....	2
PARTS DIAGRAM .....	3
TERMINAL DRAWING AND SPECIAL NOTES .....	4
TERMINAL & FUSE DESCRIPTION .....	4
HOW TO PROGRAM THE RANGER 8600 .....	6
KEYPAD PROGRAMMING EXAMPLES .....	7
PROGRAMMING PHONE NUMBERS & FORMATS .....	8-9
COMMUNICATOR FORMAT SELECTION GUIDE .....	9
OPTIONAL PROGRAMMING INSTRUCTIONS .....	10-22
AVAILABLE ZONE TYPES .....	11
PROGRAMMING THE AUXILIARY OUTPUTS .....	17
DOWNLOAD PROGRAMMING INSTRUCTIONS .....	23
PROGRAMMING WORKSHEETS .....	24-26
LOCAL TELEPHONE COMPANY INTERFACE INFO .....	28
SPECIFICATIONS & WARRANTY .....	30

**CADDX CONTROLS, INC.**  
**GLADEWATER, TEXAS**  
**800-727-2339**

# RANGER 8600 INSTALLATION MANUAL

## General Description

The Caddx Ranger 8600 is a versatile 6 zone up/downloadable security control with a built-in digital communicator. Its microcomputer design gives some of the most versatile, yet easy to use features available for most security applications today. Each of the six zones can be programmed to be one of nine different types including 24 Hour, Interior Follower, and Day zone. Each zone is individually annunciated and can be bypassed from the keypad. See page 11 for a description of all zone types.

Read the User's Manual before you begin the installation for the best overall description of how the Ranger 8600 functions. After installation of the security system, complete the information on page 1 of the User's Manual and explain the system operation to all security system users.

## Standard Parts List

The Ranger 8600 is shipped with the parts listed below.

QUANTITY	PARTS DESCRIPTION	PART #
1	MASTER CONTROL PANEL	8600
1	REMOTE KEYPAD	8601
1	16.5VAC 25VA TRANSFORMER	T-1625
10	3.3K 1/2 WATT E.O.L. RESISTORS	EOL-33
1	INSTALLATION MANUAL	IM-8600
1	USER'S MANUAL	OM-8600

## Optional Parts List

The following parts are available for use with the Ranger 8600.

OPTIONAL PARTS DESCRIPTION	PART #
LCD ALPHA NUMERIC KEYPAD	9050 / 9060E
PROGRAMMER WITH DIGITAL NUMERIC DISPLAY	8950
DOWNLOADING SOFTWARE	DL-900
CAMLOCK W/KEYS AND RETAINER	600-CL
12VDC 6AH BATTERY	B-1260
END OF LINE DEVICE	EOL-34UL
SMART PROGRAMMER	9075

## PARTS DIAGRAM

**WARNING:** FOR CONTINUED PROTECTION AGAINST THE RISK OF FIRE REPLACE ONLY WITH THE SAME TYPE AND RATING OF FUSE  
 F1 = FACTORY REPLACEABLE ONLY  
 F2 = 1 AMP F3 = 2 AMP F4 = 1 AMP

**WARNING:** TO PREVENT RISK OF ELECTRIC SHOCK ALWAYS DISCONNECT THE TELEPHONE LINE PRIOR TO SERVICING

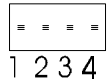
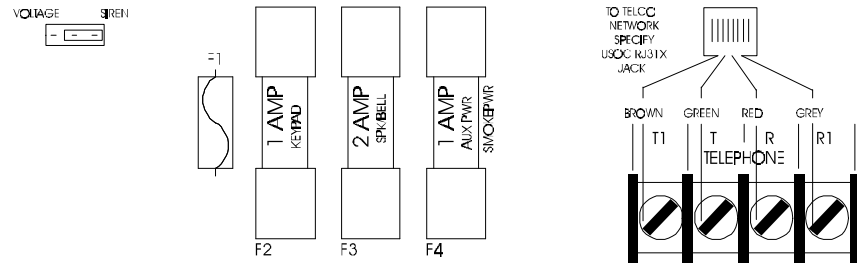

ALTERNATE OUTPUTS CURRENT LIMITED TO 250 MICROAMPS WHEN OUTPUTS POSITIVE AND 25 mA WHEN OUTPUTS NEGATIVE.

- TRANSMISSION OF THE FIRE ALARM SIGNAL TO A FIRE ALARM HEADQUARTERS OR CENTRAL STATION SHALL BE PERMITTED ONLY WITH THE APPROVAL OF THE LOCAL AUTHORITY HAVING JURISDICTION
- THE BURGLAR ALARM SIGNAL SHALL NOT BE TRANSMITTED TO A POLICE EMERGENCY NUMBER
- EQUIPMENT IS TO BE INSTALLED IN ACCORDANCE WITH NFPA 1985.55(1P)

1. ALL ZONES MUST HAVE END-OF-LINE (E.O.L.) RESISTOR ATTACHED AS SHOWN
2. MAXIMUM LOOP RESISTANCE 300 OHMS

4

FIRE LOOP HOOK UP WHEN PERMITTED BY LOCAL JURISDICTION

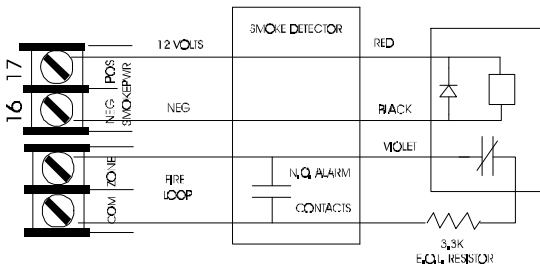

UL LISTED E.O.L. SUPERVISION RELAY (PYROTECTOR 20-40-12) OF EQUIVALENT

FOR ADDITIONAL INFORMATION AND INSTRUCTIONS REFER TO THE INSTALLATION MANUAL CADDX BULLETIN (IM-6000 OR IM-8600) AND THE USER'S MANUAL CADDX BULLETIN (UM-8000 OR UM-8600)

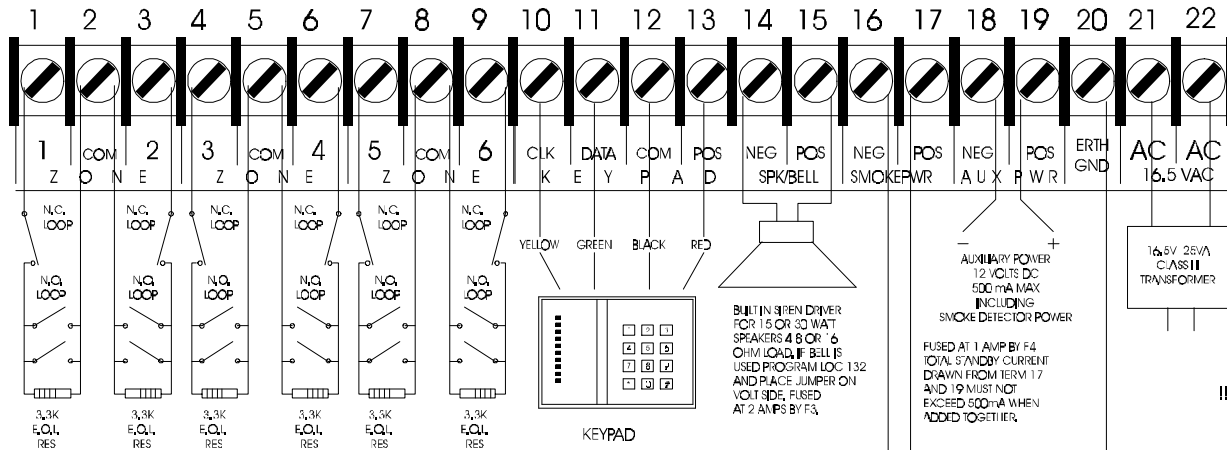

- KEYPAD
- 1) MAXIMUM 4 KEYPADS
  - 2) MAXIMUM WIRE RUN PER KEYPAD  
 a. 22 GAUGE WIRE: 200 FEET  
 b. 18 GAUGE WIRE: 600 FEET
  - 3) DO NOT DRAIN CHAIN KEYPADS. EACH MUST HAVE AN INDIVIDUAL WIRE RUN.
  - 4) ADDITIONAL KEYPADS DRAW 60 mA

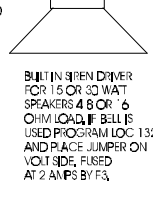

AUXILIARY POWER 12 VOLTS DC 500 mA MAX INCLUDING SMOKE DETECTOR POWER

FUSED AT 1 AMP BY F4 TOTAL STANDBY CURRENT DRAWN FROM TERM 17 AND 19 MUST NOT EXCEED 500mA WHEN ADDED TOGETHER.

\*\*\*\*\*  
**WARNING**  
 \*\*\*\*\*  
 !! DO NOT !!  
 CONNECT 110 VAC TO TERMINAL STRIP  
 !! DO NOT !!  
 CONNECT TO A RECEPTACLE THAT IS CONTROLLED BY A SWITCH

**LIGHTNING PROTECTION**  
 THE CONTROL PANEL MUST BE EARTH GROUNDED FOR LIGHTNING PROTECTION TO WORK EFFECTIVELY. THE GROUND CONNECTION SHOULD BE TO A VERIFIED COLD WATER GROUND PIPE OR A DEDICATED DRIVEN METAL ROD #10 TO 1/2 LONG, USE MINIMUM #4 GAUGE WIRE.

ZONE 1	_____	ZONE 4	_____
ZONE 2	_____	ZONE 5	_____
ZONE 3	_____	ZONE 6	_____

# CADDX RANGER 8000 / 8600

CADDX CONTROLS, INC., GLADEWATER, TX 75647

BATTERY CAPACITY FOR EMERGENCY STANDBY AT LEAST 4 HOURS. CONTROL PANEL DRAWS 80 mA IN STANDBY

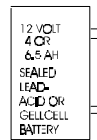

**TERMINAL DRAWING & SPECIAL NOTES**

## TERMINAL DESCRIPTION

TERMINAL	DESCRIPTION
1	Connect one side of zone 1 loop. The other side of loop to common terminal 2. Open or short causes alarm.
2	Common (-) Terminal.
3	Connect one side of zone 2 loop. The other side of loop to common terminal 2. Open or short causes alarm.
4 -9	See Terminal Drawing and repeat the above sequence for zones 3-8
10, 11, 12, 13	Connect keypad wires as follows; yellow to terminal 10, green to terminal 11, black to terminal 12, red to terminal 13. 200 ft. maximum run with 22 gauge wire, 500 ft. maximum run with 18 gauge wire. Home run cable to each keypad.
14(-) & 15(+)	Siren driver output to speaker(s), (speaker rating should be 15 watt at 8 or 16 ohm, or 30/40 watt at 4, 8, or 16 ohms). If siren driver disable is selected in location 132, output becomes voltage output, 12VDC, 1 Amp maximum load.
16(-) & 17(+)	Smoke detector power 12VDC, 100 mA maximum (For those jurisdictions which allow the Priority zone to be used with smoke detectors.)
18(-) & 19(+)	Auxiliary power, regulated 12VDC, 500 mA maximum.
20	Earth Ground, connect to a cold water pipe or 6 to 10 foot driven rod.
21 & 22	AC input, connect a 16.5V 25 VA, Class II U.L. approved transformer (included).
T1	House Telephone Tip (Brown)
T	Telephone Tip (Green)
R	Telephone Ring (Red)
R1	House Telephone Ring (Gray)
Battery Leads	Standby battery leads black(-) and red(+) connect to a 12VDC lead acid rechargeable battery. Do not connect to a dry cell battery.

## FUSE DESCRIPTION

FUSE #	DESCRIPTION
F2	KEYPAD (1 AMP)
F3	SPEAKER / BELL (2 AMP)
F4	AUXILIARY / SMOKE DETECTOR POWER (1 AMP)

## HOW TO PROGRAM THE 8600

The Ranger 8600 can be placed into the "Program" mode by either of the following methods.

1. Enter the 4 digit "Go To Program" access code (locations 28-31). At initial power-up the code in these slots is **[9]-[7]-[1]-[3]**. The Ranger 8600 must be disarmed to gain access to programming with this code.
2. Plug the optional model #8950 programmer into the 4-pin male outlet marked "program" on the Ranger 8600 P.C. Board.

When the system keypad is utilized for programming (as described by method 1 above), the Ranger 8600 will be in the "Program" mode, and the yellow LED's will display the data in location 000. The data is displayed using a Binary system. With this system the yellow zone 1 LED equals "1" when illuminated. The zone 2 LED equals "2" when illuminated. The zone 3 LED equals "4" when illuminated. The zone 4 LED equals "8" when illuminated. Thus if the data in location 000 is "9", the LED for zone 1 (=1) and zone 4 (=8) would be illuminated. By adding the two values together, (1+8=9) you would determine that the data in location 000 is "9". If the data in location 000 is "6", the LED for zone 2 (=2) and zone 3 (=4) would be added (2+4=6) indicating the data in that location to be "6". If no LED's are illuminated, the location contains a "0". To advance from location 000 through 180, press the **[#]** key. To go to a specific location, press the location number followed by the **[#]** key. The yellow LED's will then display the data in that location. Data is changed by entering a number 0 to 15 followed by **[\*]** (data enter key). Review the examples in figure 1 on page 7.

When using the optional #8950 Programmer, the programming keystrokes will be the same as with the system keypad. The #8950 however, has the ability to display the location number and the data on the numeric display. See figure 2 on page 7.

**There are three function codes that are used to program the Ranger 8600. These codes are [2]-[1]-[0]-[#], [2]-[2]-[0]-[#], and [2]-[3]-[0]-[#], and are described below.**

- After all the programming data has been entered into locations 000-180, you must enter the code **[2]-[2]-[0]-[#]** to permanently load the information into the EEPROM. **IF THIS STEP IS NOT TAKEN, THE DATA IN THE EEPROM WILL NOT CHANGE, AND THE RANGER 8600 WILL NOT CHANGE CHARACTERISTICS.**
- To change the data back to the original default values, enter the code **[2]-[1]-[0]-[#]** to load the data into the RAM memory and then **[2]-[2]-[0]-[#]** to load that data into the EEPROM.
- To exit the Program mode after it has been accessed with the four digit "Go To Program" access code, enter code **[2]-[3]-[0]-[#]**.

## PROGRAMMING EXAMPLE - FIGURE 2

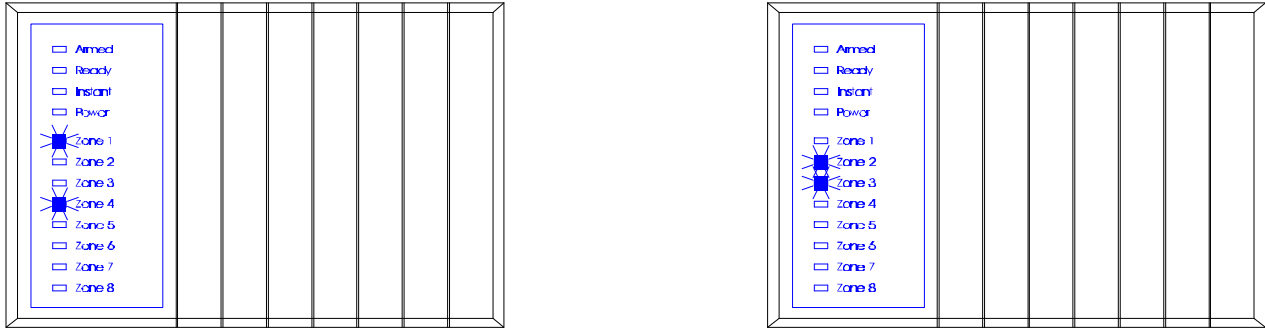

ZONE 1 LED = 1  
 ZONE 4 LED = 8 } DATA = 9

ZONE 2 LED = 2  
 ZONE 3 LED = 4 } DATA = 6

No LED's Illuminated = 0

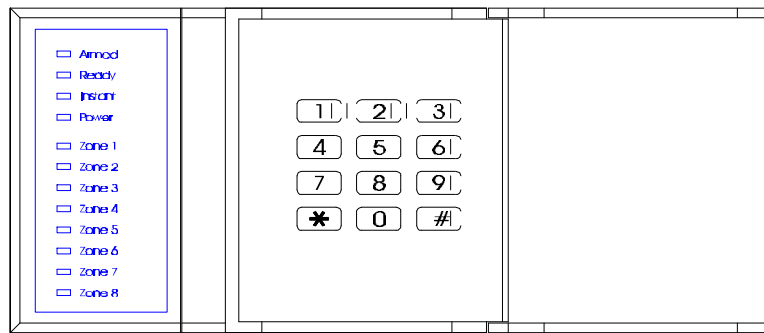

To change or enter data in location shown, enter data and follow by the [\*] Key.

Pressing the [#] Key will advance to next location, or specific location can be reached by pressing location number followed by the [#] Key.

## 8950 PROGRAMMER - FIGURE 3

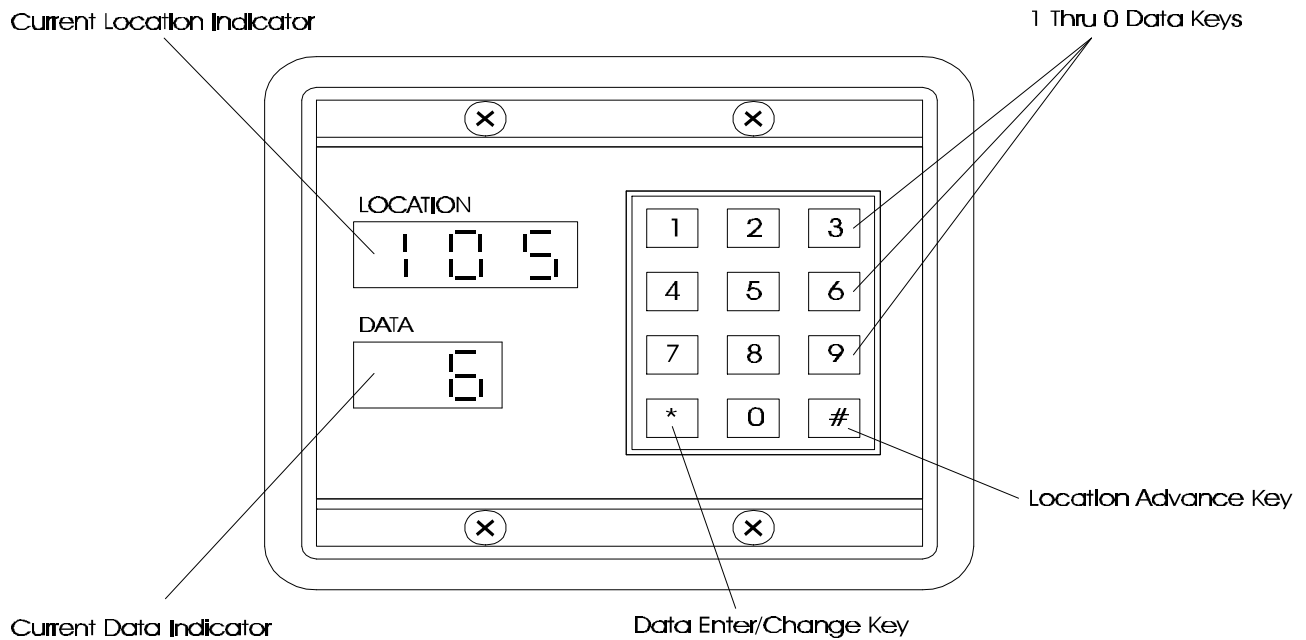

PAGES 8 & 9 DESCRIBE ALL THE LOCATIONS WHICH MUST BE PROGRAMMED FOR THE RANGER 8600 TO FUNCTION AND REPORT TO A CENTRAL STATION. OTHER OPTIONS MAY BE SELECTED BY FOLLOWING THE ADDITIONAL PROGRAMMING INSTRUCTIONS

**LOCATIONS 032-047: PROGRAMMING THE PRIMARY TELEPHONE NUMBER**

The primary telephone number is programmed in successive locations beginning with location 032. Any zero (0) within the telephone number, must be programmed as a "10". A "0" indicates the end of the phone number. Delays of four seconds can be programmed at any point in the phone number by programming a "13" in the appropriate location. If tone dialing is desired, program a "15" in the location where tone dialing should begin. If the entire number should be tone dialing, program a "15" in location 032. To dial a \*, program an "11". To dial a #, program a "12". When using split reporting, the primary number always takes priority over the secondary telephone number.

**LOCATIONS 048-051: PROGRAMMING THE ACCOUNT CODE FOR THE PRIMARY PHONE NUMBER**

The account code sent when the PRIMARY phone number is dialed is programmed in locations 048-051. Any zero (0) within the account code must be programmed as a "10", and the communicator will report a zero (0). If the account code is three digits long, use locations 048, 049, and 050. Program a "0" to indicate the end of the account code.

**LOCATION 052: PROGRAMMING COMMUNICATOR FORMAT FOR THE PRIMARY PHONE NUMBER**

Location 052 contains the communicator format used to transmit to the receiver connected to the primary phone number. Consult the instructions for your central station receiver to determine which format is compatible. To select **Ademco/Silent Knight Fast**, program a "2" in location 052. **Sescoa/Franklin Fast** requires a "4" in this location, and **Radionics 1800HZ/2300HZ Fast with Parity and Hex Capability** requires a "9" in this location. If you need another format, choose from those listed on the format table located on page 13 and program the data in location 052. If this location contains a "0", the built-in communicator will be disabled, and the Ranger 8600 will function as a local only control.

**LOCATION 053: DISABLING THE SECONDARY TELEPHONE NUMBER AS A BACKUP**

Location 053 is used to disable the secondary phone number as a "backup". This feature can be used with split reporting (locations 176-177) to prevent a report from going to the secondary telephone number after unsuccessful attempts to the primary phone number. If location 053 contains a "0", the secondary phone number will backup the primary, and the primary phone number will backup the secondary. If location 053 contains a "1", only the primary phone number will be called.

**LOCATIONS 054-069: PROGRAMMING THE SECONDARY TELEPHONE NUMBER (SPLIT REPORTING)**

Locations 054-069 contain the secondary telephone number. This number allows certain communicator reports to go to another number (split reporting), or to cause the communicator to dial a second number if the primary number does not respond after the number of attempts programmed into location 134 have been tried unsuccessfully. The same number of attempts are made with the back-up number. Tone dialing and delay instructions are the same as for the primary number.

**LOCATIONS 070-073: PROGRAMMING THE ACCOUNT CODE FOR THE SECONDARY PHONE NUMBER**

Locations 070-073 contain the account code for the secondary phone number. Any zero (0) within the account code must be programmed as a "10", and the communicator will report a zero (0). If the account code is three digits long, use locations 070, 071, and 072. Program a "0" to indicate the end of the account code. If these locations are left blank, the account code in locations 048-051 will be reported.



**LOCATION 074: PROGRAMMING COMMUNICATOR FORMAT FOR THE SECONDARY TELEPHONE NUMBER**

Location 074 contains the communicator format for the secondary phone number. Consult the instructions for your central station receiver to determine which format is compatible. To select Ademco/Silent Knight Fast, program a "2" in this location. Sescoa/Franklin Fast requires a "4" in this location, and Radionics 1800HZ/2300HZ Fast with parity and hex capability requires a "9" in this location. If you need another format, choose from those listed in the format table below, and program the appropriate data in this location. If location 074 is "0", the format programmed in location 052 will be used.

DATA	FORMAT	DESCRIPTION
"0"	LOCAL ONLY	THE COMMUNICATOR IS DISABLED
"1"	ADEMCO/SILENT KNIGHT SLOW	1900HZ TRANSMIT 1400HZ HANDSHAKE DOUBLE ROUND PARITY 10 PPS
"2"	ADEMCO/SILENT KNIGHT FAST	1900HZ TRANSMIT 1400HZ HANDSHAKE DOUBLE ROUND PARITY 20 PPS.
"3"	SESCOA/FRANKLIN SLOW	1800HZ TRANSMIT 2300HZ HANDSHAKE DOUBLE ROUND PARITY 10 PPS
"4"	SESCOA/FRANKLIN FAST	1800HZ TRANSMIT 2300HZ HANDSHAKE DOUBLE ROUND PARITY 20 PPS
"5"	EXTENDED RADIONICS SLOW	1800HZ TRANSMIT 2300HZ HANDSHAKE DOUBLE ROUND PARITY 20 PPS EXTENDED HEX CAPABILITY
"6"	EXTENDED RADIONICS SLOW	1800HZ TRANSMIT 1400HZ HANDSHAKE DOUBLE ROUND PARITY 20 PPS EXTENDED HEX CAPABILITY
"7"	EXTENDED RADIONICS FAST	1800HZ TRANSMIT 2300HZ HANDSHAKE DOUBLE ROUND PARITY 40 PPS EXTENDED HEX CAPABILITY
"8"	EXTENDED RADIONICS FAST	1800HZ TRANSMIT 1400HZ HANDSHAKE DOUBLE ROUND PARITY 40 PPS EXTENDED HEX CAPABILITY
"9"	EXTENDED RADIONICS FAST WITH PARITY	1800HZ TRANSMIT 2300HZ HANDSHAKE SINGLE ROUND W/PARITY 40 PPS EXTENDED HEX CAPABILITY
A="10"	EXTENDED RADIONICS FAST WITH PARITY	1800HZ TRANSMIT 1400HZ HANDSHAKE SINGLE ROUND W/PARITY 40 PPS EXTENDED HEX CAPABILITY
B="11"	SILENT KNIGHT 4+2 SLOW	1900HZ TRANSMIT 1400HZ HANDSHAKE DOUBLE ROUND PARITY FOUR-TWO 10PPS
C="12"	SILENT KNIGHT 4 + 2 FAST	1900HZ TRANSMIT 1400HZ HANDSHAKE DOUBLE ROUND PARITY FOUR-TWO 20PPS
D="13"	RADIONICS NON-EXTENDED	1800HZ TRANSMIT 2300HZ HANDSHAKE DOUBLE ROUND PARITY 20 PPS HEX CAPABILITY
E="14"	RADIONICS NON-EXTENDED	1800HZ TRANSMIT 1400HZ HANDSHAKE DOUBLE ROUND PARITY 20 PPS HEX CAPABILITY
F="15"	ADEMCO/SILENT KNIGHT FAST HEX	1900HZ TRANSMIT 1400HZ HANDSHAKE DOUBLE ROUND PARITY 20 PPS HEX CAPABILITY

### **LOCATIONS 000-003: PROGRAMMING THE MASTER ARM/DISARM CODE**

Locations 000-003 contain master arm/disarm code (user number 1). Location 000 contains the first digit of the code; location 003 contains the fourth digit of the code. THE CODE MUST CONTAIN FOUR (4) DIGITS. The master code can then be used in the run mode to enter arm/disarm codes 1-7.

### **LOCATIONS 004-023: PROGRAMMING THE ARM/DISARM CODE FOR USERS 2 THRU 6**

Locations 004-023 contain the arm/disarm codes for user numbers 2 thru 6. Location 004 contains the first digit of the code #2, and location 007 contains the fourth digit of code #2. THESE CODES MUST CONTAIN FOUR (4) DIGITS. To disable a code, program a "15" as the first digit of the code. These codes can be changed in the RUN mode using the master code.

### **LOCATIONS 024-027: PROGRAMMING THE DURESS CODE OR USER 7**

Locations 024-027 contain the arm/disarm code for Duress or for user number 7. Duress capability is enabled by programming a communicator code in locations 086-087. If locations 086-087 are left unprogrammed, user number 7 will act as a standard user code. If the maintenance code option is selected in location 167, locations 024-027 should not be programmed.

### **LOCATIONS 028-031: PROGRAMMING THE "GO TO PROGRAM" ACCESS CODE**

Locations 028-031 contain the "Go To Program" access code. Location 028 contains the first digit of the code and location 031 contains the fourth digit of the code. THE CODE MUST CONTAIN FOUR (4) DIGITS. With the Ranger 8600 disarmed, the "Go To Program" access code can be used to enter the program mode. To disable the "Go To Program" access code, program a "15" in location 028. The factory default setting is [9]-[7]-[1]-[3].

### **LOCATIONS 032-074: SEE PAGES 8 & 9**

### **LOCATION 075: PROGRAMMING THE ENTRY DELAY TIME**

Location 075 contains the number of 10 second increments in the entry delay. The entry delay can be programmed in 10 second increments from 10 to 150 seconds ("1" = 10 seconds through "15" = 150 seconds). For example, programming a "2" in this location will produce an entry delay of 20 seconds. (Note: A "0" entry is treated as 0 seconds). Programming a "6" in this location will produce an entry delay of 60 seconds. Factory default is 30 seconds.

### **LOCATION 076: PROGRAMMING THE EXIT DELAY TIME**

Location 076 contains the number of 10 second increments in the exit delay. The exit delay can be programmed in 10 second increments from 10 to 150 seconds ("1" = 10 seconds through "15" = 150 seconds). For example, programming a "2" in this location will produce an exit delay of 20 seconds. (Note: A "0" entry is treated as 0 seconds). Programming a "6" in this location will produce an exit delay of 60 seconds. Factory default is 60 seconds.

### **LOCATION 077: PROGRAMMING THE SIREN SHUTDOWN/RECYCLE TIMEOUT**

Location 077 contains the number of 2 minute increments in the automatic cutoff time. The automatic cutoff time can be programmed in 2 minute increments from 2 to 30 minutes ("1" = 2 min thru "15" = 30 min). For example, programming a "2" in this location will produce an automatic cutoff time of 4 minutes. Programming a "6" in this location will produce an automatic cutoff time of 12 minutes.

## **LOCATIONS 078-083: PROGRAMMING THE ZONE TYPES**

Locations 078 through 083 contain a number identifying the characteristics of each of the 8 zones. Location 078 corresponds to zone 1 and location 083 corresponds to zone 6. Each zone will factory default according to the programming worksheet. To program zone characteristics other than the default values, program a number from "1" to "9" based on the zone types available in the chart on the following page.

<b>DATA</b>	<b>AVAILABLE ZONE TYPES</b>
"1"	<b>DAY ZONE</b> - When armed, a trip produces an instant alarm. When disarmed, a trip activates the keypad sounder.
"2"	<b>24 HOUR</b> - A trip on a 24 Hour zone produces an instant alarm when armed or disarmed.
"3"	<b>ENTRY/EXIT</b> - A trip will start entry delay. The lack of a trip during exit delay will enable the Automatic Bypass or Instant mode if so programmed.
"4"	<b>INTERIOR DELAY</b> - A trip on Interior Delay zone will initiate an entry delay. It will be ignored during exit delay and when disarmed .
"5"	<b>INTERIOR FOLLOWER</b> - Interior zone that follows the delay zones. It is instant during non-delay times. It can be bypassed before arming, or by allowing it to automatically be bypassed in the Automatic Bypass/Instant mode if so programmed.
"6"	<b>INSTANT</b> - Produces an instant alarm if tripped when armed. Ignored when disarmed.
"7"	<b>24 HOUR SILENT</b> - A trip on a 24 hour silent zone will communicate to the central station when the Ranger 8600 is armed or disarmed.
"8"	<b>FIRE (PRIORITY WHEN AHJ HAS NOT APPROVED)</b> - A short on a FIRE zone (non-bypassable) will communicate to the central station when the Ranger 8600 is armed or disarmed. An open will create a Trouble condition. Keypad LED will be steady for FIRE, and flashing for Trouble.
"9"	<b>SECONDARY DELAY</b> - A secondary delay zone works like an entry/exit delay zone but has its own independent delay time (see locations 178-179).

**NOTE: WHEN PROGRAMMING THE FOLLOWING COMMUNICATOR CODES,  
A "10" MUST BE PROGRAMMED IN ORDER TO REPORT A ZERO (0).**

## **LOCATION 084-085: RESERVED**

## **LOCATION 086-087: PROGRAMMING THE RANGER 8600 FOR DURESS CODE CAPABILITY**

The Ranger 8600 has the ability to report a duress code when the system is armed or disarmed with user code number 7 and a duress communicator code is programmed in locations 086-087. If both locations are "0", the duress capability is disabled and user code number 7 can only be used as a standard arm/disarm code. Location 086 contains the standard digit, and location 087 contains the extended digit. When using 4+2 format, the number programmed in location 086 is sent as the "ones" digit. The "tens" digit is programmed in location 087. **NOTE: ENABLING THE MAINTENANCE CODE FEATURE IN LOCATION 167 WILL AUTOMATICALLY DISABLE THE DURESS FEATURE.**

## **LOCATION 088-089: PROGRAMMING FOR AUXILIARY 1, [1] & [3] DOUBLE KEYPRESS**

The Ranger 8600 has the ability to report an Auxiliary 1 code and activate the Priority siren each time the [1] and [3] keys are pressed simultaneously on the keypad. The desired reporting code is programmed in locations 088-089. If both locations are "0", the Auxiliary 1 double keypress is disabled. Location 088 contains the standard digit, and location 089 contains the extended digit. When using a 4+2 format, the number programmed in location 088 is sent as the "ones" digit. The "tens" digit is programmed in location 089. If activated, the siren can be silenced by entering any arm/disarm code.

### **LOCATION 090-091: PROGRAMMING FOR AUXILIARY 2, [4] & [6] DOUBLE KEYPRESS**

The Ranger 8600 has the ability to report an Auxiliary 2 code and activate the pulsing buzzer each time the [4] and [6] keys are pressed simultaneously on the keypad. The desired Auxiliary 2 code is programmed in locations 090-091. If both locations are "0", the Auxiliary 2 double keypress is disabled. Location 090 contains the standard digit, and location 091 contains the extended digit. When using 4+2 format, the number programmed in location 090 is sent as the "ones" digit. The "tens" digit is programmed in location 091. If activated, the keypad sounder can be silenced by entering any Arm/Disarm code.

### **LOCATION 092-093: PROGRAMMING FOR KEYPAD PANIC, [\*] & [#] DOUBLE KEYPRESS**

The Ranger 8600 has the ability to report a Keypad panic code and activate the burglary siren each time the [\*] and [#] keys are pressed simultaneously on the keypad. The desired Keypad panic code is programmed in locations 092-093. If both locations are "0", the Keypad panic double keypress is disabled. Location 092 contains the standard digit, and location 093 contains the extended digit. When using 4+2 format, the number programmed in location 092 is sent as the "ones" digit. The "tens" digit is programmed in location 093. If activated, the siren can be silenced by entering any Arm/Disarm code.

### **LOCATION 094-095: PROGRAMMING THE TAMPER FEATURE**

The Ranger 8600 has an optional tamper feature that, when enabled, will lock out the keypads for 1 minute if 30 random keypresses are made without producing a valid code. The desired tamper code should be programmed in locations 094-095. If the control is not programmed for local only, the tamper will be communicated. If both locations are "0", the tamper feature will not be enabled or reported. Location 094 contains the standard digit, and location 095 contains the extended digit. When using 4+2 format, the number programmed in location 094 is sent as the "ones" digit. The "tens" digit is programmed in location 095.

### **LOCATION 096-097: PROGRAMMING TO REPORT DOWNLOADING COMPLETE**

Locations 096-097 contain the communicator report sent each time a download session has been completed. The report will come in after a disconnect has been made from a downloading session. Location 096 contains the standard communicator code, and location 097 contains the extended communicator code. When using a 4+2 format, the number programmed in location 096 is sent as the "ones" digit. The number programmed in location 097 is sent as the "tens" digit. When using an extended format, the extended report will be sent if location 097 contains a number other than "0". If locations 096-097 are "0", this report is disabled.

### **LOCATION 098-099: PROGRAMMING FOR AUTOTEST REPORTS**

The Ranger 8600 has the ability to send autotest reports at intervals from 1 to 15 days. Locations 098-099 contain the communicator codes sent for autotest. Location 098 contains the standard communicator code, and location 099 contains the extended communicator code. When using a 4+2 format, the number programmed in location 098 is sent as the "ones" digit. The number programmed in location 099 is sent as the "tens" digit. When using an extended format, the extended report will be sent if location 099 contains a number other than "0". If locations 098-099 are "0", autotest is disabled. (NOTE: WHEN USING AUTOTEST, LOCATIONS 152-166 MUST BE PROGRAMMED.)

### **LOCATION 100-101: RESERVED FOR FUTURE USE**

### **LOCATION 102: PROGRAMMING TO REPORT CLOSINGS**

The Ranger 8600 has the ability to report a closing code each time the control is armed. The desired closing code is programmed in location 102. If this location contains a "0", closings will not be reported. When using 4+2 format, the number programmed in this location is sent as the "tens" digit. The "ones" digit is automatically the man number. When using the remote arming input, the man number is 1. When using a one button "Quick Arm" code the man number is 1. The closing report will not be initiated until the end of the exit delay.

### **LOCATION 103: PROGRAMMING TO REPORT OPENINGS**

The Ranger 8600 has the ability to report an opening code each time the control is disarmed. The desired opening code is programmed in location 103. If this location contains a "0", openings will not be reported. When using 4+2 format, the number programmed in this location is sent as the "tens" digit. The "ones" digit is automatically the man number. When using the remote arming input, the man number is 1.

### **LOCATION 104-105: PROGRAMMING THE COMMUNICATOR CODE FOR ZONE 1**

Locations 104-105 contain the communicator code to be reported each time zone 1 creates an alarm. Location 104 contains the standard digit, and location 105 contains the extended digit. When using 4+2 format, the number programmed in location 104 is sent as the "ones" digit. The "tens" digit is programmed in location 105.

### **LOCATION 106-107: PROGRAMMING THE COMMUNICATOR CODE FOR ZONE 2**

Locations 106-107 contain the communicator code to be reported each time zone 2 creates an alarm. Location 106 contains the standard digit, and location 107 contains the extended digit. When using 4+2 format, the number programmed in location 106 is sent as the "ones" digit. The "tens" digit is programmed in location 107.

### **LOCATION 108-109: PROGRAMMING THE COMMUNICATOR CODE FOR ZONE 3**

Locations 108-109 contain the communicator code to be reported each time zone 3 creates an alarm. Location 108 contains the standard digit, and location 109 contains the extended digit. When using 4+2 format, the number programmed in location 108 is sent as the "ones" digit. The "tens" digit is programmed in location 109.

### **LOCATION 110-111: PROGRAMMING THE COMMUNICATOR CODE FOR ZONE 4**

Locations 110-111 contain the communicator code to be reported each time zone 4 creates an alarm. Location 110 contains the standard digit, and location 111 contains the extended digit. When using 4+2 format, the number programmed in location 110 is sent as the "ones" digit. The "tens" digit is programmed in location 111.

### **LOCATION 112-113: PROGRAMMING THE COMMUNICATOR CODE FOR ZONE 5**

Locations 112-113 contain the communicator code to be reported each time zone 5 creates an alarm. Location 112 contains the standard digit, and location 113 contains the extended digit. When using 4+2 format, the number programmed in location 112 is sent as the "ones" digit. The "tens" digit is programmed in location 113.

### **LOCATION 114-115: PROGRAMMING THE COMMUNICATOR CODE FOR ZONE 6**

Locations 114-115 contain the communicator code to be reported each time zone 6 creates an alarm. Location 114 contains the standard digit, and location 115 contains the extended digit. When using 4+2 format, the number programmed in location 114 is sent as the "ones" digit. The "tens" digit is programmed in location 115.

### **LOCATION 116-118: RESERVED**

### **LOCATION 120-121: PROGRAMMING TO REPORT AC POWER LOSS**

The Ranger 8600 has the ability to report an AC power failure code when AC power is lost. This report can be immediate, or delayed depending on the information programmed in location 150 (AC Power Loss Delay). The desired AC failure mode should be programmed in locations 120-121. If both locations are "0", AC power failures will not be reported. Location 120 contains the standard digit, and location 121 contains the extended digit. When using 4+2 format, the number programmed in location 120 is sent as the "ones" digit. The "tens" digit is programmed in location 121.

### **LOCATION 122-123: PROGRAMMING TO REPORT LOW BATTERY**

The Ranger 8600 has the ability to report a low battery code when AC power has been lost and the battery has discharged down to 10.3 volts. The desired low battery code is programmed in locations 122-123. If both locations are "0", low battery will not be reported. Location 122 contains the standard digit, and location 123 contains the extended digit. When using 4+2 format, the number programmed in location 122 is sent as the "ones" digit. The "tens" digit is programmed in location 123.

### **LOCATION 124: PROGRAMMING FOR PRIORITY ZONE TROUBLE REPORTING**

The Ranger 8600 has the ability to report a trouble code each time a Priority zone opens. The desired trouble code is programmed in location 124. If this location contains a "0", the Priority Trouble will not be reported.

### **LOCATION 125: PROGRAMMING FOR ZONE BYPASS REPORTING**

The Ranger 8600 has the ability to report a bypass on zones 1-8. The desired bypass code is programmed in location 125. If this location contains a "0", zone bypass will not be reported. When using 4+2 format, the number programmed in this location is sent as the "tens" digit. The "ones" digit is the zone communicator code. The bypass will be reported at the end of the exit delay for non-24 hour zones. 24 hour zones will report a bypass immediately. When a bypass is removed, a restore will be reported if "Restore" is enabled in location 126.

### **LOCATION 126: PROGRAMMING THE COMMUNICATOR CODE FOR RESTORAL**

Location 126 contains the communicator code that will be sent for restoral of a zone. If this location contains a "0", no restorals will be reported. If a restoral code is programmed and an extended format is selected, the restorals will be reported by zone. If a restoral code is programmed and an extended format is not selected, a restoral code will be sent when all of the previously reported conditions have restored. When using 4+2 format, the number programmed in this location is sent as the first, or "tens" digit. The second, or "ones" digit will be the "ones" digit of the zone or condition that restored.

### **LOCATION 127: PROGRAMMING THE COMMUNICATOR CODE FOR CANCEL (EXCEPTION OPENING)**

Location 127 contains the communicator code that will be sent for cancel. The cancel code programmed in this location will be sent if an arm/disarm code is entered after a trip on zones 1 through 8 has been reported (excluding 24 hour zones). After a cancel has been reported, no loop restorals will be transmitted on non-24 Hour zones. If this location contains a "0", cancel is disabled. When using 4+2 format, the number programmed in this location is sent as the "tens" digit. The "ones" digit is the man number of the person that cancelled. When using a remote arming input, the man number is 1.

### **LOCATION 128: PROGRAMMING THE COMMUNICATOR TO ABORT**

Location 128 is used to enable the communicator abort. A "1" in this location will cause the Ranger 8600 to abort the report of a trip on any non-24 hour zone, if an arm/disarm code is entered prior to central station connection. If this location contains a "0", the Ranger 8600 will not abort any reports.

### **LOCATION 129: PROGRAMMING FOR SILENT PANIC/HOLD-UP**

Location 129 is used to silence the audible output for a panic/hold-up alarm. Programming a "1" in this location will silence the audible output during a panic/hold-up alarm. If this location contains a "0", the Ranger 8600 will have an audible panic/hold-up output.

### **LOCATION 130: ENABLING THE SWINGER SHUTDOWN**

Location 130 is used to enable the burglary zone swinger shutdown. The number programmed in this location, will determine the number of trips the Ranger 8600 will allow, before bypassing all burglary zones (1-8) which have tripped during an arming cycle. The bypassed zones will not report trips to a central station, and the local siren or bell will not sound for these zones. A zone trip will not be added to the number count until after the zone has tripped more than once. A zone trip will only be added each time the siren cycle starts. If this location contains a "0", this feature is disabled. A zone which has been bypassed by this feature will be reported if bypass reporting is enabled in location 125. **If "Immediate Restore By Zone" is enabled in location 137, multiple reports may be transmitted during a siren cycle without adding to the trip count.**

### **LOCATION 131: AUTOMATIC BYPASS / INSTANT ARMING**

Location 131 is used to enable automatic "Instant Arming". Programming a "1" in this location will cause the control to automatically enter the "Instant" mode and bypass interior follower zones if a fault is not detected on an entry/exit zone during the exit delay. Programming a "3" in this location (Automatic Bypass), will cause the interior follower zones to become bypassed if a fault is not detected on an entry/exit zone, yet will not change the status of the entry/exit zone. If this location contains a "0", these features are disabled. Pressing the [\*] key when the system is armed, will cause the "Instant" light to toggle. When the "Instant" light is on, the entry/exit zone is instant; when off, the entry/exit zone is delayed. The [\*] key will toggle the "Instant" mode regardless of the programming data in this location.

### **LOCATION 132: BUILT-IN SIREN DRIVER / 1 AMP VOLTAGE OUTPUT**

The built-in siren driver has a steady sound (for Priority zone type), and a yelp sound (for Burglary and Panic). Factory default is "0", enabling this feature. If the built-in siren driver is **NOT** to be used, take the following procedure. First, remove the jumper marked voltage/siren on the PC board. Next, program a "1" in location 132. Finally, replace the jumper in the voltage position. Terminals 21 & 22 will now output 1 Amp at 12VDC.

### **LOCATION 133: L.E.D. EXTINGUISH FEATURE**

Keypad LEDs (excluding the A.C. LED) will be extinguished after 60 seconds of keypad inactivity, if a "1" is programmed in location 133. The LEDs will become illuminated immediately upon a keypress or alarm condition.

### **LOCATION 134: ENTERING THE NUMBER OF DIAL ATTEMPTS**

Location 134 is used to enter the number of dial attempts (1 to 15 attempts) the communicator will try for the appropriate phone number(s) before ending the notification process. If this location contains an "8", the communicator will make eight attempts to the first number, and then eight attempts to a second number, if a second number is programmed as backup.

### **LOCATION 135: POWER UP CONDITION**

If a "1" is programmed in location 135, the Ranger 8600 will power-up disarmed if there is a total power shutdown and battery failure. If a "2" is programmed in this location, it will power up armed. If this location contains a "0", the Ranger 8600 will power up in the condition it was in at power down. A watchdog circuit reset will cause the Ranger 8600 to reset to the selected condition.

### **LOCATION 136: POWER UP DELAY**

If a "1" is programmed in location 136, the Ranger 8600 will not delay 60 seconds before accepting open or short inputs from any zone. If a "0" is programmed, sensors on all zones are allowed 60 seconds to stabilize at power-up.. After 60 seconds, the Ranger will once again accept loop opens or shorts as an alarm condition. This 60 second period will also be initiated after exiting the program mode, or a watchdog circuit reset condition.

**LOCATION 137: IMMEDIATE RESTORE BY ZONE**

If a "1" is programmed in location 137, restoral signals will follow the restore condition and report restores immediately after the condition has unfaulted. A non-extended format will not send a restore message until all zones and trouble conditions have restored. If this location contains a "0", the restore signal or signals will be reported only after siren timeout.

**LOCATION 138: NO ARMING WITH A ZONE BYPASSED**

If a "1" is programmed in location 138, the Ranger 8600 will not arm with any zone bypassed. If programmed with a "0", up to 5 of the 6 burglary zones can be bypassed, and the Ranger 8600 can still be armed. If an "8" is programmed, it will prevent beeping if A.C. power is lost and having to re-enter codes two times to stop the beeping.

**LOCATION 139: PROGRAMMING THE QUICK ARM DIGIT**

Location 139 contains the "Quick Arm" digit. To enable, program a digit (1-9) in this location. If the "Quick Arm" digit is the same as the first digit of the Master code (user 1), the "Chime" feature will not function. The "Quick Arm" digit cannot be the same as the first digit of the "Go To Program" code. Default is "0", disabled.

**LOCATION 140: PRIORITY SIREN CUTOFF INHIBIT**

If a "1" is programmed in location 140, a Priority zone type siren will sound continuously until an arm/disarm code is entered. If this location contains a "0", the Priority zone type siren will shutdown after the amount of time programmed in location 077 has elapsed. Programming in this location does not affect the burglary siren.

**LOCATION 141: DOUBLE LINE EXTENDED ALARM REPORTING**

If an extended format is selected in location 052, and a "1" is programmed in location 141, all reports will be double line extended. If location 141 contains a "0", only non-alarm reports will be extended (restore, cancel, opening, closing, bypass, and trouble). With this format, the central station will receive the report on two printed lines. The example below shows a burglary report from zone 6 of account number 999. Zone 6 was programmed to report a 3.

LINE 1:	999 (ACCOUNT CODE)	3 (CODE)
LINE 2:	333 (ACCOUNT CODE)	6 (EXT CODE)

**LOCATION 142: SIREN/BELL TEST FEATURE**

Programming a "1" in location 142 will cause the siren/bell to come on each time the [1] and [7] keys are pressed simultaneously. The siren/bell can be silenced with an arm/disarm code. The siren/bell test does not cause the communicator to transmit a message.

**LOCATION 143: RESETTABLE AUXILIARY POWER**

Programming a "1" in location 143 will cause the 8600 (when in the disarmed state) to interrupt the smoke detector power each time the [#] button is pressed. If this location contains a "0", the smoke detector power will reset only after the [#] button is pressed when zone(s) designated as Priority zone types are on steady for alarm or blinking for trouble.

**LOCATION 144: EUROPEAN PULSE DIAL RATIO**

Programming a "1" in location 144 will change the pulse dialing make/break ratio and interdigit spacing to conform to most European telecom standards.



### **ION 145-148: PROGRAMMING THE AUXILIARY OUTPUTS**

Four of the functions in the following table are available on the 4-pin connector on the PC board. These outputs are often used to switch small relays, LED's, trip long range radio, or to add a remote sensor. For example, to create an LED that lights for alarm memory, program a "7" into location 145. Wire the positive lead of the LED to terminal 26 (positive aux power) and the negative lead through a limiting resistor of approximately 650 ohms to PIN #1 (top pin) of the aux output pin connector. If the LED operation is "ON" when you want it to be "OFF", see location 149. **NOTE: NO MORE THAN 20 MILLIAMPS CAN BE SUPPLIED FROM THESE TERMINALS.**

DATA	ACTIVATION ON	NOTES
"0"	ARMED STATE	LATCHED OUTPUT
"1"	READY	LATCHED OUTPUT
"2"	BURG/PANIC SIREN	RECYCLED OUTPUT
"3"	PRIORITY SIREN	RECYCLED OUTPUT
"4"	ARMED WITH BYPASS	LATCHED OUTPUT
"5"	AC POWER	LATCHED OUTPUT
"6"	LOW BATTERY	LATCHED OUTPUT
"7"	ALARM MEMORY	LATCHED OUTPUT
"8"	ENTRY	LATCHED OUTPUT
"9"	EXIT	MOMENTARY OUTPUT

### **LOCATIONS 149: INVERTING THE AUXILIARY OUTPUTS**

Auxiliary outputs are normally "OFF", and turn "ON" when the selected condition occurs. For outputs you wish to reverse, add up their values according to the chart below and program the sum in this location. For example, to reverse outputs 2 and 3, program a "6" ( $2 + 4 = "6"$ ) in location 149.

VALUE	DESCRIPTION
1	Invert auxiliary 1 output
2	Invert auxiliary 2 output
4	Invert auxiliary 3 output
8	Invert auxiliary 4 output

### **LOCATION 150: AC POWER LOSS DELAY FEATURE**

Location 150 is used to disable the 5 minute delay before reporting an AC power failure. If a "1" is programmed in this location, AC power failures will be reported immediately. If a "0" is programmed in this location, AC power failures will not be reported until the power has been off for 5 minutes.

### **LOCATION 151: PROGRAMMING THE NUMBER OF RINGS TO ANSWER DOWNLOAD CALL**

Location 151 contains the number of rings the 8600 must detect before answering the telephone when initiating a download. If a number from "1" to "15" is programmed in this location, the control will answer after **THIS** number of rings has been detected. If a "0" is programmed in this location, the 8600 will not answer the download call. (SEE LOCATION 210: ANSWERING MACHINE DEFEAT)

### **LOCATION 152: PROGRAMMING THE NUMBER OF DAYS LEFT UNTIL AUTOTEST REPORT**

Location 152 contains the number of days left until the next autotest report. If this location contains a "0", an autotest signal will be reported the first time the current time equals the autotest time programmed in locations 162-165. Locations 098-099 must be programmed to enable autotest reporting.

### **LOCATION 153: PROGRAMMING THE CLOCK, CURRENT MONTH**

Location 153 contains the current month. The month must be programmed using a number from "1" to "12". This location must be programmed when using the maintenance code feature (see location 167).

### **LOCATION 154: PROGRAMMING THE CLOCK, CURRENT YEAR - TENS DIGIT**

Location 154 contains the current year - tens digit. If the current year is 1994, this location should contain a 9, which is the tens digit of the current year.

### **LOCATION 155: PROGRAMMING THE CLOCK, CURRENT YEAR - ONES DIGIT**

Location 155 contains the current year - ones digit. If the current year is 1994, this location should contain a "4", which is the ones digit of the current year. If the current year is 1995, this location should contain a "5", which is the ones digit of the current year.

### **LOCATION 156: PROGRAMMING THE CLOCK, CURRENT DAY OF THE MONTH - TENS DIGIT**

Location 156 contains the current day of the month - tens digit. If the current day of the month is the 5th (05), this location should contain a "0", which is the current day of the month - tens digit. If the current day of the month is the 26th, this location should contain a "2".

### **LOCATION 157: PROGRAMMING THE CLOCK, CURRENT DAY OF THE MONTH - ONES DIGIT**

Location 157 contains the current day of the month - ones digit. If the current day of the month is the 5th (05), this location should contain a "5", which is the current day of the month - ones digit. If the current day of the month is the 26th, this location should contain a "6".

### **LOCATION 158: PROGRAMMING THE CLOCK, CURRENT HOUR - TENS DIGIT**

Location 158 contains the current hour - tens digit. The time is entered in 24 hour time. If the current time is 5:25 PM, the 24 hour time is 17:25, so this location should contain a "1", which is the current hour - tens digit. If the current time is 9:36 AM, the 24 hour time is 09:36, so this location should contain a "0".

### **LOCATION 159: PROGRAMMING THE CLOCK, CURRENT HOUR - ONES DIGIT**

Location 159 contains the current hour - ones digit. The time is entered in 24 hour time. If the current time is 5:25 PM, the 24 hour time is 17:25, so this location should contain a "7", which is the current hour - ones digit. If the current time is 9:36 AM, the 24 hour time is 09:36, and this location should contain a "9".

### **LOCATION 160: PROGRAMMING THE CLOCK, CURRENT MINUTES - TENS DIGIT**

Location 160 contains the current minutes - tens digit. The time is entered in 24 hour time. If the current time is 5:25 PM, the 24 hour time is 17:25, so location 160 should contain a "2", which is the current minutes - tens digit. If the current time is 9:36 AM, the 24 hour time is 09:36, and this location should contain a "3".

### **LOCATION 161: PROGRAMMING THE CLOCK, CURRENT MINUTES - ONES DIGIT**

Location 161 contains the current minutes - ones digit. The time is entered in 24 hour time. If the current time is 5:25 PM, the 24 hour time is 17:25, so this location should contain a "5", which is the current minutes - ones digit. If the current time is 9:36 AM, the 24 hour time is 09:36, and this location should contain a "6".

### **LOCATION 162: PROGRAMMING THE AUTOTEST TIME, HOUR - TENS DIGIT**

Location 162 contains the tens digit of the hour that the autotest report is initiated. The time is entered in 24 hour time. If the desired autotest time is 5:25 PM, the 24 hour time is 17:25, so this location should contain a "1", which is the tens digit of the desired hour for autotest. If the desired autotest time is 9:36 AM, the 24 hour time is 09:36, and this location should contain a "0".

### **LOCATION 163: PROGRAMMING THE AUTOTEST TIME, HOUR - ONES DIGIT**

Location 163 contains the ones digit of the hour that the autotest report is desired. The time is entered in 24 hour time. If the desired autotest time is 5:25 PM, the 24 hour time is 17:25, so this location should contain a "7", which is the ones digit of the hour for autotest. If the desired autotest time is 9:36 AM, the 24 hour time is 09:36, and this location should contain a "9".

### **LOCATION 164: PROGRAMMING THE AUTOTEST TIME, MINUTES - TENS DIGIT**

Location 164 contains the tens digit, of the minutes after the hour that the autotest is desired. The time is entered in 24 hour time. If the desired autotest time is 5:25 PM, the 24 hour time is 17:25, so this location should contain a "2", which is the tens digit of the minutes for autotest time. If the desired autotest time is 9:36 AM, the 24 hour time is 09:36, this location should contain a "3".

### **LOCATION 165: PROGRAMMING THE AUTOTEST TIME, MINUTES - ONES DIGIT**

Location 165 contains the ones digit, of the minutes after the hour that the autotest is desired. The time is entered in 24 hour time. If the desired autotest time is 5:25 PM, the 24 hour time is 17:25, so this location should contain a "5", which is the ones digit of the minutes for autotest time. If the desired autotest time is 9:36 AM, the 24 hour time is 09:36, and this location should contain a "6".

### **LOCATION 166 PROGRAMMING THE AUTOTEST TIME REPORTING INTERVALS**

Location 166 contains the number of days between automatic test reports. If a report is desired every 7 days, this location should contain a "7". Valid entries are "1" to "15" days.

### **LOCATION 167: PROGRAMMING FOR ROTATING MAINTENANCE CODES**

The Ranger 8600 has the ability to automatically generate a different MAINTENANCE arm/disarm code daily. This code is produced using the current date programmed in locations 153-157, and the 4 digit complex or "seed code", programmed in locations 168-171. This code can then be generated by using the CG-800 "Code Generating Software" which is designed to operate on a DOS based personal computer. If this location contains a "1", the maintenance code is enabled and the code will change daily. If this location contains a "3", the code will change on the first day of each month. If location 167 contains a "0", this feature is disabled, and the user #7 arm/disarm code will be the code programmed in locations 024-027. NOTE: Activating the maintenance code will automatically disable the duress code, regardless of what is programmed in locations 086-087.

**LOCATION 168-171: PROGRAMMING THE SEED CODE FOR ROTATING MAINTENANCE CODES**

Locations 168-171 contain the complex, or "seed code" required to generate rotating maintenance codes as described in the paragraph above. These locations allow a unique set of codes for different buildings or complexes. NOTE: ACTIVATING THE MAINTENANCE CODE WILL AUTOMATICALLY DISABLE THE DURESS CODE, REGARDLESS OF WHAT IS PROGRAMMED IN LOCATIONS 086-087.

**LOCATION 172: PROGRAMMING USER 7 OR MAINTENANCE CODE OPENING COMMUNICATOR CODE**

The Ranger 8600 has the ability to give an opening report each time user number 7 disarms the control. The desired opening code should be programmed in this location. This feature can be used in conjunction with the rotating maintenance code to give an opening report each time the maintenance code is used to disarm. When using an extended format, the extended code will always be a 7.

**LOCATION 173: PROGRAMMING USER 7 OR MAINTENANCE CODE CLOSING COMMUNICATOR CODE**

The Ranger 8600 has the ability to give a closing report each time user number 7 arms the control. The desired closing code should be programmed in this location. This feature can be used in conjunction with the rotating maintenance code to give a closing report each time the maintenance code is used to arm. When using an extended format, the extended code will always be a 7. CAUTION! If a "Quick Arm" code has been selected, and the first digit of the rotating maintenance code is the same digit as the "Quick Arm" code, the maintenance closing code will not be reported.

**LOCATION 174: PROGRAMMING ZONES 3 THRU 6 FOR NORMALLY CLOSED OPERATION ONLY**

Location 174 is used to program zones 3,4,5,& 6 for normally closed operation only, eliminating the need for the end of line resistors on that zone. When a zone is programmed for normally closed operation only, a short will not change the loop condition, and an open on that zone will produce a faulted condition. This feature will be ignored by any Priority zone. To program a zone for normally closed only, refer to the chart below, and program the appropriate data in this location.

<b>ZONES TO PROGRAM FOR N/C OPERATION</b>	<b>DATA TO PROGRAM IN LOCATION 174</b>
6	"1"
5	"2"
5 & 6	"3"
4	"4"
4 & 6	"5"
4 & 5	"6"
4, 5, & 6	"7"
3	"8"
3 & 6	"9"
3 & 5	A ="10"
3, 5, & 6	B ="11"
3 & 4	C ="12"
3, 4, & 6	D ="13"
3, 4, & 5	E ="14"
3, 4, 5, & 6	F ="15"

**LOCATION 175: PROGRAMMING ZONES 1, AND/OR 2 FOR NORMALLY CLOSED OPERATION ONLY**

Location 175 is used to program zones 1 and/or 2 for normally closed operation only, eliminating the need for the end of line resistors on these zones. When a zone is programmed for normally closed operation, a short on that zone will not change the loop condition, and an open on that zone will produce a faulted condition. This feature will be ignored by any Priority zone. To program a zone for normally closed only, refer to the chart on the following page, and program the appropriate data in this location.

ZONES TO PROGRAM FOR N/C OPERATION	DATA TO PROGRAM IN LOCATION 175
2	"1"
1	"2"
2 & 1	"3"

**LOCATION 176: SPLIT REPORTING - PROGRAMMING TAMPER, DOWNLOAD COMPLETE, AND AUTOTEST TO REPORT TO THE SECONDARY PHONE NUMBER**

The 8600 is capable sending certain reports to the secondary telephone number. This feature known as split reporting can be used to send alarm reports to one number and supervisory reports to another number. When using split reporting with the 8600, the primary telephone number always takes priority over the secondary telephone number. The 8600 always sends zone and alarm reports to the primary telephone number. There are 7 reports that can be programmed to report to the second telephone number. Location 176 is used to force up to three of these individual reports to the second telephone number. To program tamper, download complete, or autotest to report to the secondary telephone number, use the following chart and program the appropriate number in location 176.

REPORTS TO SEND TO SECONDARY NUMBER	DATA TO PROGRAM IN LOCATION 176
AUTOTEST	"2"
DOWNLOAD COMPLETE	"4"
DOWNLOAD COMPLETE ; AUTOTEST	"6"
TAMPER	"8"
TAMPER ; AUTOTEST	A = "10"
TAMPER ; DOWNLOAD COMPLETE	C = "12"
TAMPER ; DOWNLOAD COMPLETE ; AUTOTEST	E = "14"

**LOCATION 177: SPLIT REPORTING - PROGRAMMING AC POWER FAIL, LOW BATTERY, OPEN/CLOSE, AND MAINTENANCE OPEN/CLOSE TO REPORT TO THE SECONDARY PHONE NUMBER**

The 8600 is capable sending certain reports to the secondary telephone number. This feature known as split reporting can be used to send alarm reports to one number, and supervisory reports to another number. When using split reporting with the 8600, the primary telephone number always takes priority over the secondary number. The 8600 always sends zone and alarm reports to the primary number. There are 7 reports that can be programmed to report to the second telephone number. Location 177 is used to force up to four of these individual reports to the second number. To program AC power fail, low battery, open/close, or maintenance code open/close to report to the secondary number, use the following chart and program the appropriate data in this location.

REPORTS TO SEND TO SECONDARY NUMBER	DATA FOR LOCATION 177
MAINT CODE OPEN/CLOSE	"1"
OPEN/CLOSE	"2"
OPEN/CLOSE; MAINT CODE OPEN/CLOSE	"3"
LOW BATTERY	"4"
LOW BATTERY; MAINT CODE OPEN/CLOSE	"5"
LOW BATTERY; OPEN/CLOSE	"6"
LOW BATTERY; OPEN/CLOSE; MAINT CODE OPEN/CLOSE	"7"
AC FAIL	"8"
AC FAIL; MAINT CODE OPEN/CLOSE	"9"
AC FAIL; OPEN/CLOSE	A ="10"
AC FAIL; OPEN/CLOSE; MAINT CODE OPEN/CLOSE	B ="11"
AC FAIL; LOW BATTERY	C ="12"
AC FAIL; LOW BATTERY; MAINT CODE OPEN/CLOSE	D ="13"
AC FAIL; LOW BATTERY; OPEN/CLOSE	E ="14"
AC FAIL; LOW BATTERY; OPEN/CLOSE; MAINT CODE OPEN/CLOSE	F ="15"

**LOCATION 178: PROGRAMMING THE SECONDARY ENTRY DELAY (ZONE TYPE 9)**

Location 178 contains the number of 10 second increments in the secondary entry delay. This delay can be programmed from 10 to 150 seconds ("1" = 10 sec thru "15" = 150 sec).

**LOCATION 179: PROGRAMMING THE SECONDARY EXIT DELAY (ZONE TYPE 9)**

Location 179 contains the number of 10 second increments after arming, before trips will be recognized on a zone type 9. The exit delay can be programmed in 10 second increments from 10 to 150 seconds ("1" = 10 seconds thru "15" = 150 seconds). (Note: A "0" entry is treated as zero (0) seconds). If the exit delay time in this location is less than that of location 076, this secondary delay will follow the amount of time in location 076.

**LOCATION 180: PROGRAMMING THE LOOP RESPONSE TIME**

Location 180 is used to program the loop response time for all zones programmed as fast loop response in locations 186-193. The response time is equal to 20 milliseconds times the number programmed in this location ("1" = 20 milliseconds and "5" = 100 milliseconds). If this location contains a "0", the loop response time will be 500 milliseconds.

**LOCATIONS 181-185: DO NOT PROGRAM THESE LOCATIONS (each should be "0")**

## **THE FOLLOWING LOCATIONS ARE ACCESSIBLE ONLY THROUGH DOWNLOADING**

### **LOCATIONS 186-193: CONTROL PANEL ACCESS CODE**

Locations 186-193 contain the eight digit access code the 8600 must receive from the downloading software before the panel will permit downloading to occur. The factory default code is listed in the instructions provided with the CADDX download software package.

### **LOCATIONS 194-209: CALL BACK TELEPHONE NUMBER**

The presence of a phone number in locations 194-209 will cause the control panel to dial back this number after a successful panel access code has been entered. If a telephone number is present, the control panel will hang up for approximately 36 seconds (insuring that the calling party has disconnected), then it will call back. Any zero (0) within the telephone number must be programmed as an "A". If tone dialing is desired, program an "F" in the location where tone dialing should begin. If the entire number should be tone dialing, program an "F" in location 194. Four second delays can be obtained anywhere in the sequence by programming a "D" in the appropriate delay location. **WARNING: CALLBACK PHONE NUMBER SHOULD ALWAYS BE REVIEWED FOR ACCURACY BEFORE DISCONNECTING.**

### **LOCATION 210: ANSWERING MACHINE DEFEAT**

Location 210 contains the answering machine defeat enable. To defeat an answering machine, two telephone calls must be made to the premises. On the first call, let the phone ring the same number of times (or less) as the number programmed in location 210 (maximum 3). The control panel will detect these rings and start a 45 second timer. If a call comes in during that 45 second time frame, the control panel will answer on the first ring. To disable this feature, program a "0" in this location.

### **LOCATION 211: LOCAL PROGRAMMING LOCKOUT**

Location 211 is used to disable local programming lockout. If a "5" is programmed in this location, all local programming is locked out. If an "A" is programmed in this location, all programming functions related to the digital communicator will be locked out. Any other number in location 211 will allow all local programming.

### **LOCATION 212: CONTROL PANEL SHUTDOWN**

Location 212 is used to shut down the control panel. Programming an "A" in this location will completely shutdown the control panel. The keypad will appear "dead", and the siren and communicator will not operate. **WARNING: EXTREME CARE SHOULD BE TAKEN NOT TO INADVERTENTLY PROGRAM THIS LOCATION.**

### ARM/DISARM CODES 1-7

LOCATION	PAGE	DESCRIPTION	DATA 1	DATA 2	DATA 3	DATA 4	DEFAULT
000-003	10	USER #1 ARM / DISARM CODE					"1-2-3-4"
004-007	10	USER #2 ARM / DISARM CODE					"15" DISABLED
008-011	10	USER #3 ARM / DISARM CODE					"15" DISABLED
012-015	10	USER #4 ARM / DISARM CODE					"15" DISABLED
016-019	10	USER #5 ARM / DISARM CODE					"15" DISABLED
020-023	10	USER #6 ARM / DISARM CODE					"15" DISABLED
024-027	10	USER #7 ARM / DISARM CODE					"15" DISABLED
028-031	10	"GO TO PROGRAM" ACCESS CODE					"9-7-1-3"

### PHONE NUMBERS, ACCOUNT CODES, & FORMATS

032-039	8	PRIMARY PHONE NUMBER DIGITS 1 - 8								"0" DISABLED
040-047	8	PRIMARY PHONE NUMBER DIGITS 9 - 16								"0" DISABLED
048-051	8	PRIMARY ACCOUNT CODE								"0" DISABLED
052	8	PRIMARY FORMAT								"0" DISABLED
053	8	SECONDARY PHONE NUMBER AS BACK-UP								"0" ENABLED
054-061	8	SECONDARY PHONE NUMBER DIGITS 1 - 8								"0" DISABLED
062-069	8	SECONDARY PHONE NUMBER DIGITS 9 - 16								"0" DISABLED
070-073	8	SECONDARY ACCOUNT CODE								"0" DISABLED
074	9	SECONDARY FORMAT								"0" DISABLED

### CONTROL & COMMUNICATOR FEATURES

LOCATION	PAGE	DESCRIPTION	DATA	DEFAULT
075	10	ENTRY DELAY TIME (10 SECOND INCREMENTS)		"3" 30 SECONDS
076	10	EXIT DELAY TIME (10 SECOND INCREMENTS)		"6" 60 SECONDS
077	10	SIREN SHUTDOWN / RECYCLE TIME OUT (2 MINUTE INCREMENTS)		"4" 8 MINUTES
078	11	ZONE 1 TYPE		"3" ENTRY / EXIT
079	11	ZONE 2 TYPE		"5" INT FOLLOWER
080	11	ZONE 3 TYPE		"6" INSTANT
081	11	ZONE 4 TYPE		"6" INSTANT
082	11	ZONE 5 TYPE		"6" INSTANT
083	11	ZONE 6 TYPE		"6" INSTANT
084	11	RESERVED		RESERVED
085	11	RESERVED		RESERVED

LOCATION	PAGE	DESCRIPTION	ZONE ID	EVENT/EXT CODE	DEFAULT
086-087	11	DURESS COMMUNICATOR CODE			"0" DISABLED
088-089	11	AUX 1 COMMUNICATOR CODE			"0" DISABLED
090-091	12	AUX 2 COMMUNICATOR CODE			"0" DISABLED
092-093	12	KEYPAD PANIC COMMUNICATOR CODE			"2 - 0"
094-095	12	TAMPER COMMUNICATOR CODE			"0" DISABLED
096-097	12	DOWNLOAD COMPLETE COMM CODE			"0" DISABLED
098-099	12	AUTOTEST COMMUNICATOR CODE			"0" DISABLED
100-101	12	RESERVED			RESERVED
102	12	CLOSING COMMUNICATOR CODE		MAN NUMBER	"0" DISABLED



LOCATION	PAGE	DESCRIPTION	ZONE ID	EVENT/EXT CODE	DEFAULT
103	12	OPENING COMMUNICATOR CODE		MAN NUMBER	"0" DISABLED
104-105	13	ZONE 1 COMMUNICATOR CODE			"1 - 0"
106-107	13	ZONE 2 COMMUNICATOR CODE			"2 - 0"
108-109	13	ZONE 3 COMMUNICATOR CODE			"3 - 0"
110-111	13	ZONE 4 COMMUNICATOR CODE			"4 - 0"
112-113	13	ZONE 5 COMMUNICATOR CODE			"5 - 0"
114-115	13	ZONE 6 COMMUNICATOR CODE			"6 - 0"
116-117	13	RESERVED			RESERVED
118-119	13	RESERVED			RESERVED
120-121	14	AC POWER LOSS COMMUNICATOR CODE			"0" DISABLED
122-123	14	LOW BATTERY COMMUNICATOR CODE			"0" DISABLED
124	14	TROUBLE COMMUNICATOR CODE		ZONE NUMBER	"0" DISABLED
125	14	ZONE BYPASS COMMUNICATOR CODE		ZONE NUMBER	"0" DISABLED
126	14	RESTORE COMMUNICATOR CODE		ZONE NUMBER	"0" DISABLED
127	14	CANCEL COMMUNICATOR CODE		MAN NUMBER	"0" DISABLED

LOCATION	PAGE	DESCRIPTION	DATA	DEFAULT
128	14	ABORT COMMUNICATOR CODE		"0" DISABLED
129	14	KEYPAD PANIC SILENT OR AUDIBLE		"0" AUDIBLE
130	15	NUMBER OF ALARMS FOR SWINGER SHUTDOWN		"0" DISABLED
131	15	AUTO BYPASS/ INSTANT ARMING		"0" DISABLED
132	15	SIREN DRIVER OR VOLTAGE OUTPUT		"0" SIREN DRIVER
133	15	LED EXTINGUISH FEATURE		"0" DISABLED
134	15	NUMBER OF DIAL ATTEMPTS		"8" EIGHT ATTEMPTS
135	15	POWER UP CONDITION		"0" LAST CONDITION
136	15	POWER UP DELAY		"0" 60 SEC DELAY
137	15	IMMEDIATE RESTORE BY ZONE		"0" DISABLED
138	16	NO ARMING WITH ZONE BYPASSED		"0" DISABLED
139	16	QUICK ARM DIGIT		"0" DISABLED
140	16	FIRE SIREN CUTOFF INHIBIT		"0" RECYCLES
141	16	DOUBLE LINE EXTENDED REPORTING		"0" DISABLED
142	16	SIREN/BELL TEST FEATURE		"0" DISABLED
143	16	RESETTABLE AUXILIARY POWER		"1" POWER RESET
144	16	EUROPEAN PULSE DIAL RATIO		"0" DISABLED
145	17	AUXILIARY OUTPUT #1		"0" ARMED
146	17	AUXILIARY OUTPUT #2		"1" READY
147	17	AUXILIARY OUTPUT #3		"2" BURG SIREN
148	17	AUXILIARY OUTPUT #4		"3" FIRE SIREN
149	17	INVERTING THE AUXILIARY OUTPUTS		"0" HIGH GOING LOW
150	17	AC POWER LOSS DELAY		"0" DELAYED
151	18	NUMBER OF RINGS TO ANSWER DOWNLOAD CALL		"8" EIGHT RINGS
152	18	NUMBER OF DAYS LEFT UNTIL AUTOTEST		UNDEFINED
153	18	PROGRAM CLOCK, CURRENT MONTH		UNDEFINED
154	18	PROGRAM CLOCK, CURRENT YEAR - TENS DIGIT (1994)		UNDEFINED
155	18	PROGRAM CLOCK, CURRENT YEAR - ONES DIGIT (1994)		UNDEFINED

LOCATION	PAGE	DESCRIPTION	DATA	DEFAULT
156	18	PROGRAM CLOCK, CURRENT DAY OF MONTH - TENS DIGIT		UNDEFINED
157	18	PROGRAM CLOCK, CURRENT DAY OF MONTH - ONES DIGIT		UNDEFINED
158	18	PROGRAM CLOCK, CURRENT HOUR - TENS DIGIT		UNDEFINED
159	18	PROGRAM CLOCK, CURRENT HOUR - ONES DIGIT		UNDEFINED
160	19	PROGRAM CLOCK, CURRENT MINUTE - TENS DIGIT		UNDEFINED
161	19	PROGRAM CLOCK, CURRENT MINUTE - ONES DIGIT		UNDEFINED
162	19	PROGRAM AUTOTEST TIME, HOUR - TENS DIGIT		"0"
163	19	PROGRAM AUTOTEST TIME, HOUR - ONES DIGIT		"0"
164	19	PROGRAM AUTOTEST TIME, MINUTE - TENS DIGIT		"0"
165	19	PROGRAM AUTOTEST TIME, MINUTE - ONES DIGIT		"0"
166	19	PROGRAM AUTOTEST TIME REPORTING INTERVALS		"0"
167	19	ROTATING MAINTENANCE CODES ENABLE		"0" DISABLED
168	20	ROTATING MAINTENANCE CODES - SEED CODE DIGIT 1		"0"
169	20	ROTATING MAINTENANCE CODES - SEED CODE DIGIT 2		"0"
170	20	ROTATING MAINTENANCE CODES - SEED CODE DIGIT 3		"0"
171	20	ROTATING MAINTENANCE CODES - SEED CODE DIGIT 4		"0"
172	20	USER #7 (MAINTENANCE CODE) OPENING REPORT		"0" DISABLED
173	20	USER #7 (MAINTENANCE CODE) CLOSING REPORT		"0" DISABLED
174	20	PROGRAM ZONES 3 THRU 6 FOR NORMALLY CLOSED OPERATION		"0" SUPERVISED
175	21	PROGRAM ZONES 1 AND/OR 2 FOR NORMALLY CLOSED OPERATION		"0" SUPERVISED
176	21	SPLIT REPORT - TAMPER, DOWNLOAD COMPLETE, & AUTOTEST		"0" PHONE #1
177	22	SPLIT REPORT - AC FAILURE, LOW BAT, OPEN/CLOSE, & MAINT OPEN/CLOSE		"0" PHONE #1
178	22	SECONDARY ENTRY DELAY TIME		"0" INSTANT
179	22	SECONDARY EXIT DELAY TIME		"0"
180	22	LOOP RESPONSE TIME		"0" 500 MS
181-185	22	RESERVED		RESERVED

**REMEMBER! AFTER ALL DATA HAS BEEN ENTERED, PRESS [2]-[2]-[0]-[#] TO STORE DATA IN EEPROM!**

**THE FOLLOWING LOCATIONS ARE ACCESSIBLE ONLY THROUGH DOWNLOADING**

LOCATION	PAGE	DESCRIPTION	DATA	DEFAULT
186-193	23	CONTROL PANEL ACCESS CODE		"86000000"
194-201	23	CALLBACK PHONE NUMBER - DIGITS 1 - 8		"0" DISABLED
202-209	23	CALLBACK PHONE NUMBER - DIGITS 9 - 16		"0" DISABLED
210	23	ANSWERING MACHINE DEFEAT		"0" DISABLED
211	23	LOCAL PROGRAMMING LOCKOUT		"0" NOT LOCKED
212	23	CONTROL PANEL SHUTDOWN		"0" CONTROL ON

## **LOCAL TELEPHONE COMPANY INTERFACE INFORMATION**

### **TELEPHONE CONNECTION REQUIREMENTS**

Except for telephone company provided ringers, all connections to the telephone network shall be made through standard plugs and standard telephone company provided jacks or equivalent in such a manner as to allow for immediate disconnection of the terminal equipment. Standard jacks shall be so arranged that if the plug connected thereto is withdrawn, no interference to the operation of the equipment at the customers premises which remains connected to the telephone network, shall occur by reason of such withdrawal.

### **INCIDENCE OF HARM**

Should terminal equipment or protective circuitry cause harm to the telephone network, the telephone company shall, where practical, notify the customer that temporary discontinuance of service may be required; however, where prior notice is not practical, the telephone company may temporarily discontinue service if such action is deemed reasonable in the circumstances. In the case of such temporary discontinuance, the telephone company shall promptly notify the customer who will be given the opportunity to correct the situation. The customer also has the right to bring a complaint to the FCC if he feels the disconnection is not warranted.

### **CHANGES IN TELEPHONE COMPANY EQUIPMENT OR FACILITIES**

The telephone company may make changes in its communications facilities, equipment, operations, or procedures where such action is reasonably required and proper in its business. Should any such change render the customers terminal equipment incompatible with the telephone company facilities, the customer shall be given adequate notice to make modifications to maintain uninterrupted service.

### **GENERAL**

The FCC prohibits customer provided terminal equipment be connected to party lines.

### **IMPORTANCE OF THE RINGER EQUIVALENCE NUMBER**

The Ringer Equivalence Number of this device is 0.2 B. This number is a representation of the electrical load that it applies to your telephone line.

### **MALFUNCTION OF THE EQUIPMENT**

In the event that the device should fail to operate properly, the customer shall disconnect the equipment from the telephone line to determine if it is the customers equipment that is not functioning properly. If the problem is with the device the customer shall discontinue use until it is repaired.

### **EQUIPMENT INFORMATION**

MANUFACTURER OF CONNECTING EQUIPMENT: CADDX CONTROLS INC.  
FCC REGISTRATION NUMBER: GCQ4DC-17266-AL-E  
RINGER EQUIVALENCE: 0.2 B

## SPECIFICATIONS

<b>OPERATING POWER</b>	<b>16.5 VAC 25 VA Transformer</b>
<b>AUXILIARY POWER</b>	<b>12 VDC 500mA</b>
<b>LOOP RESISTANCE</b>	<b>300 Ohms Maximum</b>
<b>BUILT-IN SIREN DRIVER</b>	<b>2-tone (Steady and Yelp)</b>
<b>LOOP RESPONSE</b>	<b>Selectable to 500mS</b>
<b>OPERATING TEMPERATURE</b>	<b>32 to 120 degrees F</b>
<b>KEYPAD DIMENSIONS</b>	<b>5.50" Wide 4.25" High .850" Deep</b>
<b>METAL ENCLOSURE DIMENSION</b>	<b>11.25" Wide 11.25" High 3.50" Deep</b>
<b>SHIPPING WEIGHT</b>	<b>9 lbs.</b>

### FIVE YEAR LIMITED WARRANTY

**CADDX CONTROLS, INC. GUARANTEES THIS PRODUCT AGAINST DEFECTIVE PARTS AND WORKMANSHIP FOR TWENTY-FOUR (24) MONTHS FROM DATE OF MANUFACTURING. IF ANY DEFECT APPEARS DURING THE WARRANTY PERIOD RETURN IT TO CADDX, POSTAGE PREPAID. THE UNIT WILL BE REPAIRED AND RETURNED.**

**FOR THE REMAINING 36 MONTHS OF WARRANTY, THE UNIT WILL BE REPAIRED FOR A FEE NOT TO EXCEED \$10.00 PLUS SHIPPING AND HANDLING.**

**CADDX ASSUMES NO LIABILITY FOR CONSEQUENTIAL OR INDIRECT DAMAGE AND ACCEPTS NO RESPONSIBILITY FOR REPAIRING DAMAGE TO THE PRODUCT CAUSED BY MISUSE, CARELESS HANDLING, OR WHERE REPAIRS HAVE BEEN MADE BY OTHERS.**

**NO OTHER GUARANTEE, WRITTEN OR VERBAL, IS AUTHORIZED BY OR ON BEHALF OF CADDX CONTROLS, INC., GLADEWATER, TEXAS.**

**CADDX CONTROLS, INC.  
1420 NORTH MAIN STREET  
GLADEWATER, TEXAS 75647  
TOLL FREE 800-727-2339  
FAX 903-845-6811**